

DETTAGLIO TAMPONATURA

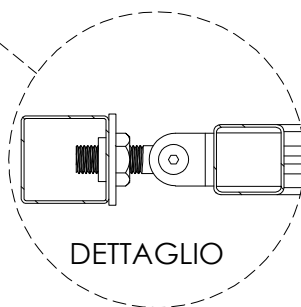
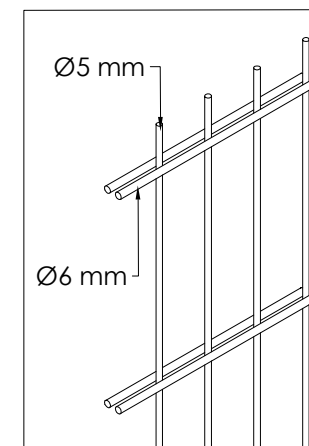

DESCRIZIONE: CANCELLO DOPPIA ANTA CON PIANTONI		DIMENSIONI: 3020 x 1740 mm
TRATTAMENTO: ZINCATO E VERNICIATO		COLORE: GRIGIO - VERDE - BIANCO
	RECINZIONI E CONSULENZE EDILI Via Archimede, 1 37010 Affi (Vr) Tel. 045-6261394 Fax 045-6260266 info@arredilsrl.it www.arredilsrl.it	<h1>ART. CA8</h1>

La ditta ARREDIL s.r.l. si riserva la proprietà di questo disegno con divieto di riproduzione o trasferirlo a terzi senza autorizzazione scritta.